

### Portable ultrasonic flow measurement of gas in hazardous areas

Portable instrument for non-invasive, quick ultrasonic flow measurement with clamp-on technology for all types of piping

#### Features

- Precise bi-directional and highly dynamic flow measurement with the non-invasive clamp-on technology
- High precision at fast and slow flow rates, high temperature and zero point stability
- Portable, easy-to-use flow transmitter with 2 flow channels, multiple inputs, an integrated data logger with a serial interface
- Extremely resistant carbon fiber housing
- Covered by FM class I Div. 2 certification
- Compact and very lightweight, allowing the measuring system to be easily carried as personal luggage, e.g. for offshore visits
- Water tight; resistant against oil, many liquids and dirt
- Li-Ion battery provides up to 25 hours of measurement operation
- Automatic loading of calibration data and transducer detection for a fast and easy set-up (less than 5 min), providing precise and long-term stable results
- User-friendly design
- Transducers available for a wide range of inner pipe diameters and fluid temperatures
- Rugged transducers (FM Class 1 Div. 2, resistant to rough environments and humidity)
- Robust, water-tight (NEMA 4) transport case with comprehensive accessories
- QuickFix for fast mounting of the flow transmitter in difficult conditions
- Including measurement of liquids

#### Applications

Designed for the following industries:

- Upstream (on- and offshore)
- Midstream and downstream (pipelines and refineries)
- Chemical industry
- Energy sector (e.g. HVAC, geothermal, power plants)



FLUXUS G608 supported by handle



Measurement with transducers mounted with the portable Variofix VP



Measurement with the flow transmitter fixed to the pipe with the QuickFix pipe mounting fixture

## Table of contents

<b>Function</b> .....	3
Measurement principle .....	3
Calculation of volumetric flow rate .....	3
Number of sound paths .....	4
Typical measurement setup .....	4
Standard volumetric flow rate .....	5
<b>Flow transmitter</b> .....	6
Technical data .....	6
Dimensions .....	7
Standard scope of supply .....	7
Adapters (optional) .....	8
<b>Transducers</b> .....	9
Transducer selection .....	9
Transducer order code .....	12
Technical data .....	13
<b>Transducer mounting fixture</b> .....	18
<b>Coupling materials for transducers</b> .....	19
<b>Damping mats (optional)</b> .....	20
<b>Connection systems</b> .....	21
Transducer cable .....	21
<b>Clamp-on temperature probe (optional)</b> .....	22
<b>Wall thickness measurement (optional)</b> .....	23

## Function

### Measurement principle

In order to measure the flow of a fluid in a pipe, ultrasonic signals are used, employing the transit time difference principle. Ultrasonic signals are emitted by a transducer installed on the pipe and received by a second transducer. These signals are emitted alternately in the flow direction and against it.

As the fluid in which the signals propagate is flowing, the transit time of the ultrasonic signals in the flow direction is shorter than against the flow direction.

The transit time difference,  $\Delta t$ , is measured and allows the flowmeter to determine the average flow velocity along the propagation path of the ultrasonic signals. A flow profile correction is then performed in order to obtain the area averaged flow velocity, which is proportional to the volumetric flow rate.

Two integrated microprocessors control the entire measuring process. This allows the flowmeter to remove disturbance signals, and to check each received ultrasonic wave for its validity which reduces noise.

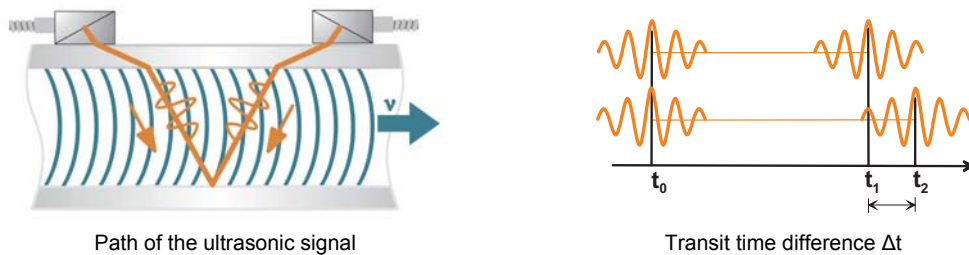

### Calculation of volumetric flow rate

$$\dot{V} = k_{Re} \cdot A \cdot k_a \cdot \Delta t / (2 \cdot t_{fl})$$

where

- $\dot{V}$  = volumetric flow rate
- $k_{Re}$  = fluid mechanics calibration factor
- $A$  = cross-sectional pipe area
- $k_a$  = acoustical calibration factor
- $\Delta t$  = transit time difference
- $t_{fl}$  = transit time in the fluid

### Number of sound paths

The number of sound paths is the number of transits of the ultrasonic signal through the fluid in the pipe. Depending on the number of sound paths, the following methods of installation exist:

- **reflect arrangement**  
The number of sound paths is even. Both of the transducers are mounted on the same side of the pipe. Correct positioning of the transducers is easier.
- **diagonal arrangement**  
The number of sound paths is odd. Both of the transducers are mounted on opposite sides of the pipe.
- **direct mode**  
Diagonal arrangement with 1 sound path. This should be used in the case of a high signal attenuation by the fluid, pipe or coatings.

The preferred method of installation depends on the application. While increasing the number of sound paths increases the accuracy of the measurement, signal attenuation increases as well. The optimum number of sound paths for the parameters of the application will be determined automatically by the transmitter.

As the transducers can be mounted with the transducer mounting fixture in reflect arrangement or diagonal arrangement, the number of sound paths can be adjusted optimally for the application.

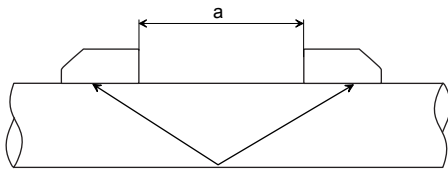

Reflect arrangement, number of sound paths: 2

a = transducer distance

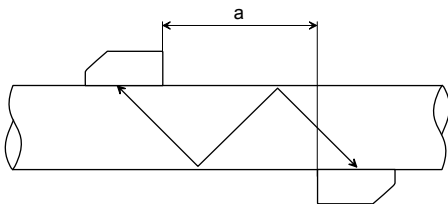

Diagonal arrangement, number of sound paths: 3

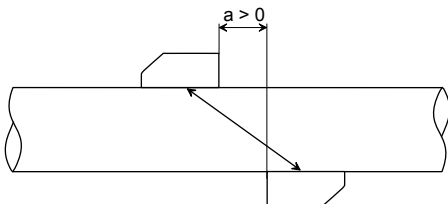

Direct mode, number of sound paths: 1

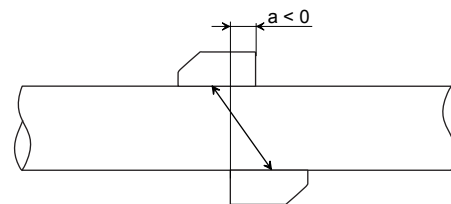

Direct mode, number of sound paths: 1, negative transducer distance

### Typical measurement setup

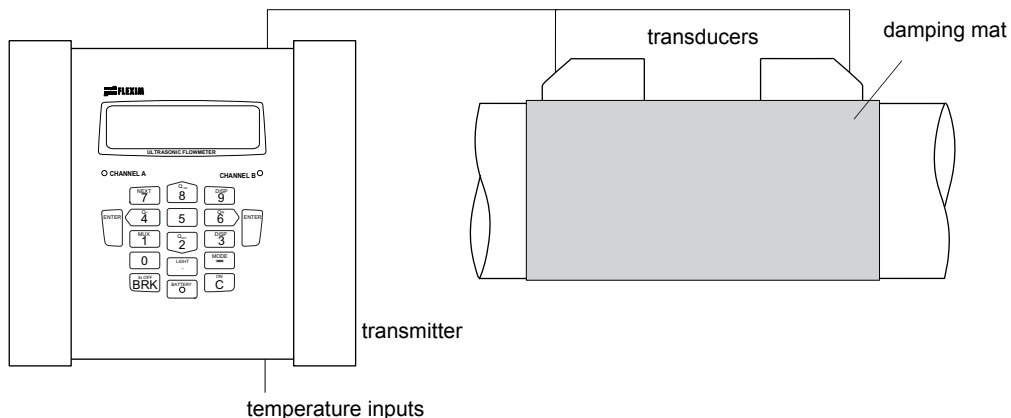

Example of a reflect arrangement

### Standard volumetric flow rate

The standard volumetric flow rate can be selected as physical quantity to be measured. It will be calculated internally by:

$$\dot{V}_N = \dot{V} \cdot p/p_N \cdot T_N/T \cdot 1/K$$

where

$\dot{V}_N$	=	standard volumetric flow rate
$\dot{V}$	=	operating volumetric flow rate
$p_N$	=	standard pressure (absolute value)
$p$	=	operating pressure (absolute value)
$T_N$	=	standard temperature in K
$T$	=	operating temperature in K
$K$	=	compressibility coefficient of the gas: ratio of the compressibility factors of the gas at operating conditions and at standard conditions $Z/Z_N$

The operational pressure  $p$  and the operational temperature  $T$  of the fluid will be entered directly as fixed values into the transmitter.

or:

If inputs are installed (optional), pressure and temperature can be measured by the customer and fed in the transmitter.

The gas compressibility coefficient  $K$  of the gas is entered in the transmitter:

- as fixed value or
- as approximation according to e.g. AGA8 or GERG

## Flow transmitter

### Technical data

<b>FLUXUS</b>	<b>G608**-F2</b>
design	portable, FM class I Div. 2
	
<b>measurement</b>	
measurement principle	transit time difference correlation principle
flow velocity	0.03 to 115 ft/s, depending on pipe diameter
repeatability	0.15 % of reading $\pm 0.03$ ft/s
fluid	all acoustically conductive gases, e.g. nitrogen, air, oxygen, hydrogen, argon, helium, ethylene, propane
temperature compensation	corresponding to the recommendations in ANSI/ASME MFC-5.1-2011
<b>accuracy</b>	
volumetric flow rate	$\pm 1$ to $3$ % of reading $\pm 0.03$ ft/s depending on application $\pm 0.5$ % of reading $\pm 0.03$ ft/s with field calibration
<b>flow transmitter</b>	
power supply	100 to 230 V/50 to 60 Hz (power supply unit, outside of explosive atmosphere) 10.5 to 15 V DC (socket at transmitter, with power adapter (optional)) integrated battery
integrated battery - operating time	Li-Ion, 7.2 V/6.2 Ah > 14 h (without inputs and backlight) > 25 h (1 measuring channel, ambient temperature > 50 °F, without inputs and backlight)
power consumption	< 6 W (with inputs and backlight)
number of flow measuring channels	2
damping	0 to 100 s, adjustable
measuring cycle (1 channel)	100 to 1000 Hz
response time	1 s (1 channel), option: 70 ms
housing material	PA, TPS, PC, Polyester, stainless steel
degree of protection	NEMA 4
dimensions	see dimensional drawing
weight	4.9 lb
fixation	QuickFix pipe mounting fixture
ambient temperature	14 to 140 °F
display	2 x 16 characters, dot matrix, backlight
menu language	English, German, French, Dutch, Spanish
<b>explosion protection</b>	
<b>F</b> <b>M</b>	marking NI/Cl. I /Div. 2/ GP. A,B,C,D / T5 Ta = 60 °C 
<b>measuring functions</b>	
physical quantities	operating volumetric flow rate, standard volumetric flow rate, mass flow rate, flow velocity
totalizer	volume, mass
calculation functions	average, difference, sum
diagnostic functions	sound speed, signal amplitude, SNR, SCNR, standard deviation of amplitudes and transit times
<b>communication interfaces</b>	
diagnostic interfaces	- RS232 - USB (with adapter)
<b>serial data kit</b>	
software	- FluxDiagReader: download of measured values and parameters, graphical presentation - FluxDiag (optional): download of measurement data, graphical presentation, report generation - FluxSubstanceLoader: upload of fluid data sets
cable	RS232
adapter	RS232 - USB
<b>data logger</b>	
loggable values	all physical quantities, totalized values and diagnostic values
capacity	> 100 000 measured values
<b>transport case</b>	
dimensions	19.7 x 15.7 x 7.5 in

<b>FLUXUS</b>	<b>G608**-F2</b>
<b>inputs</b>	
	The inputs are galvanically isolated from the transmitter.
number	max. 4
accessories	input adapter (if number of inputs > 2)
	<b>temperature input</b>
type	Pt100/Pt1000
connection	4-wire
range	-238 to +1040 °F
resolution	0.01 K
accuracy	±0.01 % of reading ±0.03 K

For the technical data in the flow measurement of liquids mode see Technical specification TSFLUXUS\_F608xx-F2Vx-x.

### Dimensions

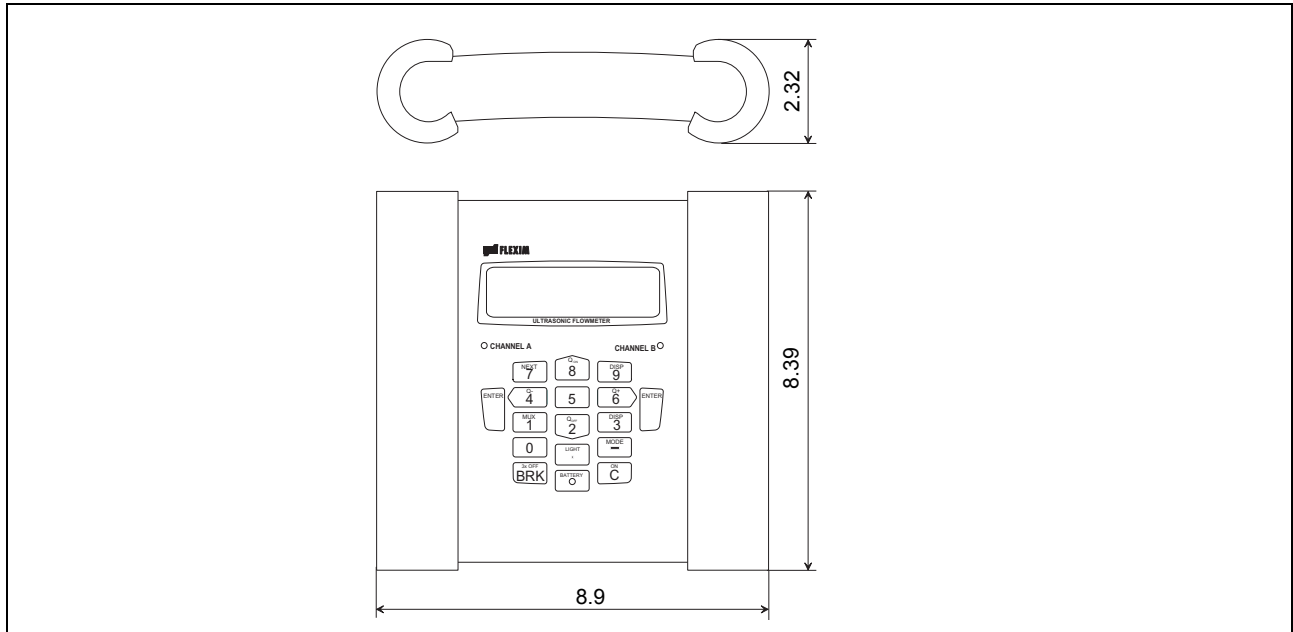

in inch

### Standard scope of supply

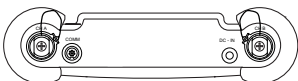
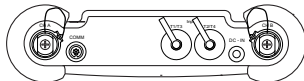
	<b>G608 Standard</b>	<b>G608 CA-Energy</b>
application	flow measurement of gas	flow measurement of compressed air, industrial gases and liquids
	2 independent measuring channels	
	calculation of standard volumetric flow rate	calculation of standard volumetric flow rate, with optional use of current measured temperature values
		liquids: integrated heat flow computer for monitoring of energy flows
<b>inputs</b>		
temperature input	-	4
<b>accessories</b>		
transport case	x	x
power supply unit, mains cable	x	x
battery	x	x
input adapter	-	2
QuickFix pipe mounting fixture for transmitter	x	x
serial data kit	x	x
measuring tape	x	x
wall thickness probe	-	x
user manual, safety instructions, Quick start guide	x	x
connector board at the upper side of the transmitter		

### Adapters (optional)

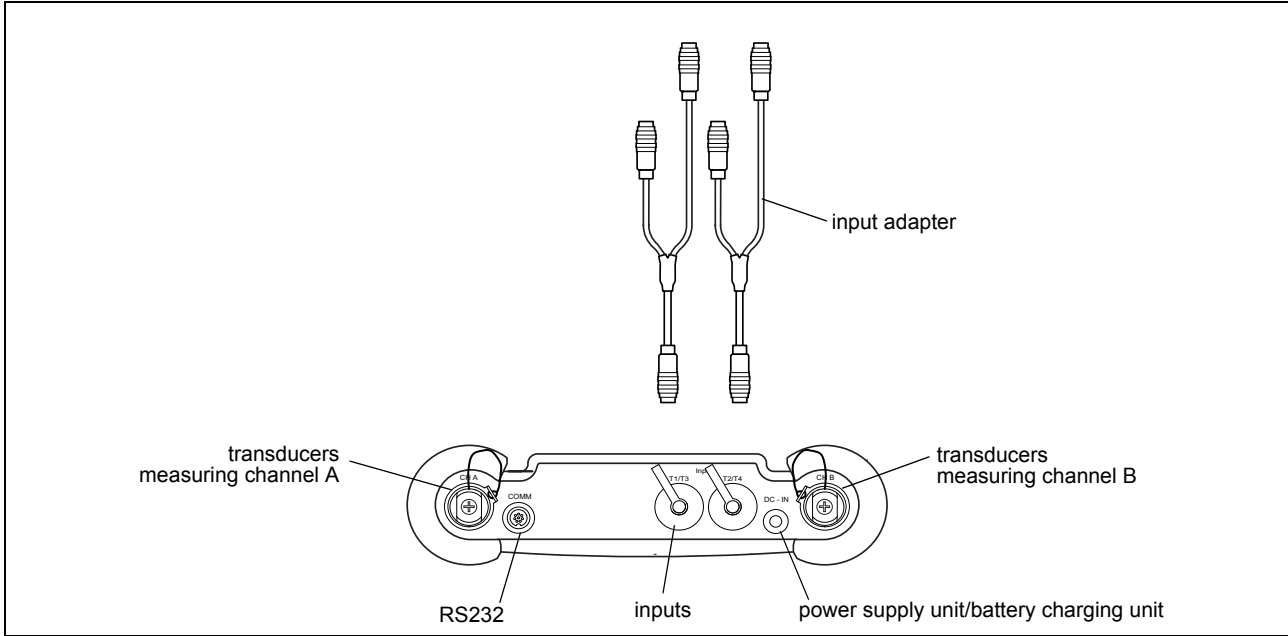



## Transducers

### Transducer selection

#### Step 1a

Select a Lamb wave transducer:

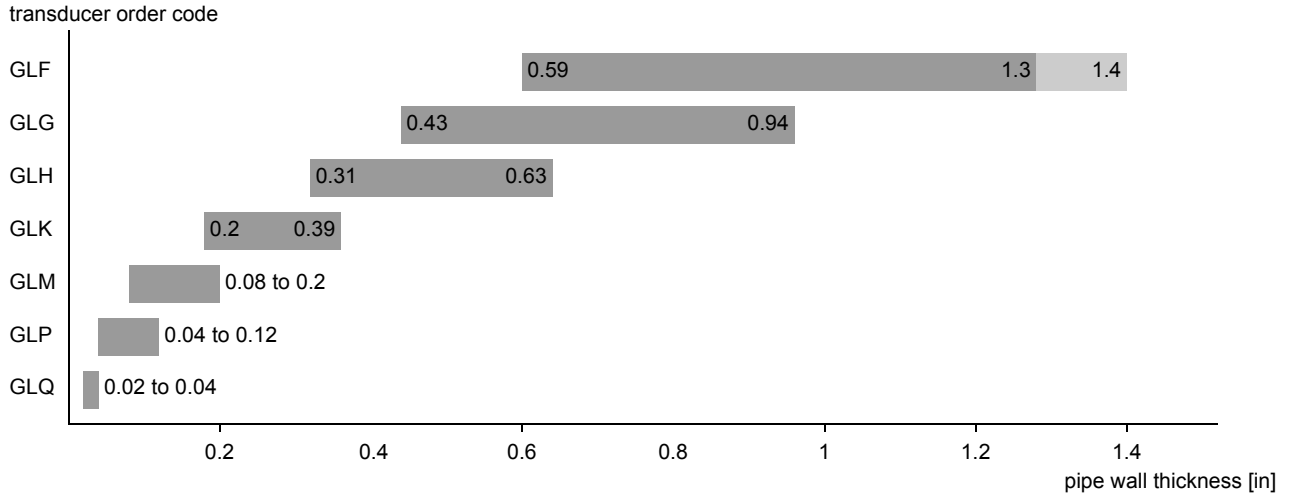

#### Step 1b

If the pipe wall thickness is not in the range of the Lamb wave transducers, select a shear wave transducer:

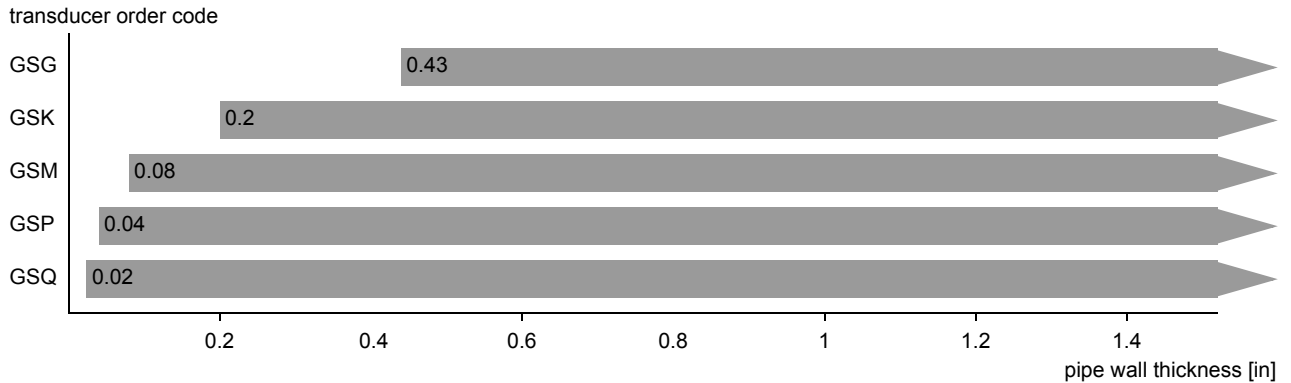

recommended
  possible

#### Step 2

inner pipe diameter  $d$  dependent on the flow velocity  $v$  of the fluid in the pipe

The transducers are selected from the characteristics (see next page). Lamb wave transducers are selected from the left column, shear wave transducers from the right column.

Lamb wave transducers: If the values  $d$  and  $v$  are not in the range, the diagonal arrangement with 1 sound path may be used, i.e. the same characteristics can be used with doubling the inner pipe diameter. If the values are still not in the range, shear waves transducers regarding the pipe wall thickness have to be selected in step 1b.

Lamb wave transducer<sup>1</sup>

shear wave transducer<sup>1</sup>

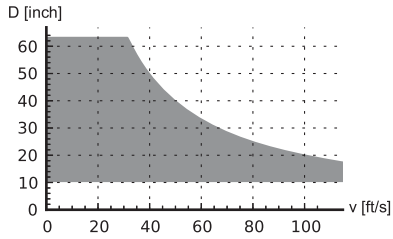

GLF

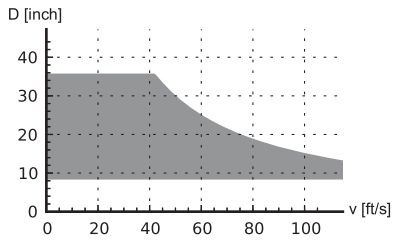

GLG

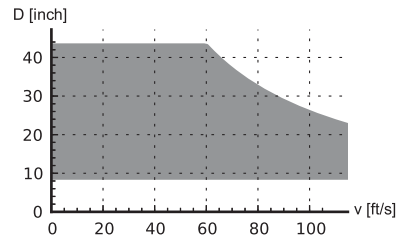

GSG

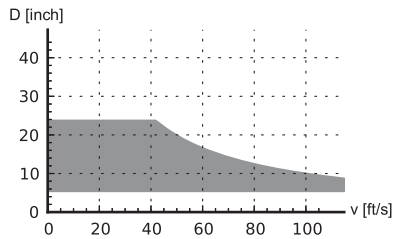

GLH

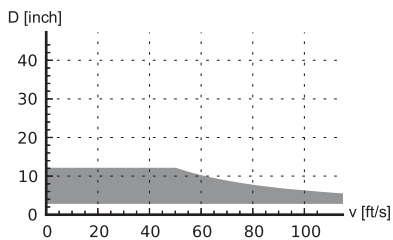

GLK

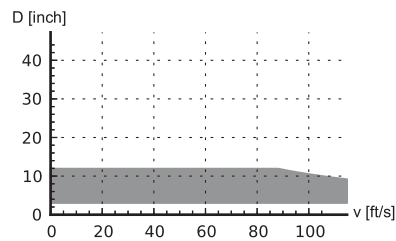

GSK

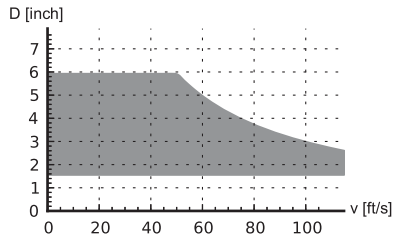

GLM

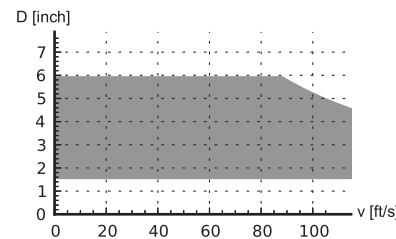

GSM

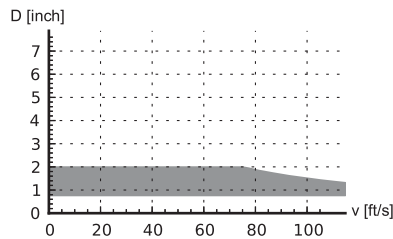

GLP

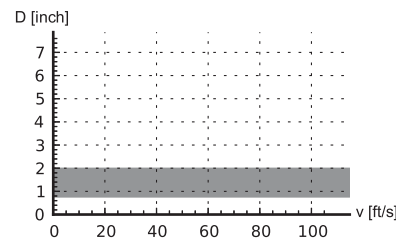

GSP

<sup>1</sup> inner pipe diameter and max. flow velocity for a typical application with natural gas, nitrogen, oxygen in reflect arrangement with 2 sound paths (Lamb wave transducers)/1 sound path (shear wave transducers)

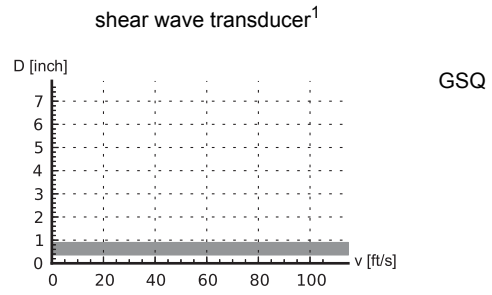
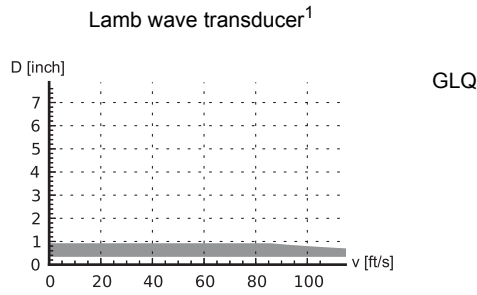

<sup>1</sup> inner pipe diameter and max. flow velocity for a typical application with natural gas, nitrogen, oxygen in reflect arrangement with 2 sound paths (Lamb wave transducers)/1 sound path (shear wave transducers)

**Step 3**

min. fluid pressure

Lamb wave transducer			
transducer order code	fluid pressure <sup>1</sup> [psi]		
	metal pipe		plastic pipe
	min.	min. extended	min.
GLF	218	145	15
GLG	218	145	15
GLH	218	145	15
GLK	218 (d > 4.7 in) 145 (d < 4.7 in)	145 (d > 4.7 in) 44 (d < 4.7 in)	15
GLM	145 (d > 2.4 in) 73 (d < 2.4 in)	44 (d < 2.4 in)	15
GLP	145 (d > 1.4 in) 73 (d < 1.4 in)	44 (d < 1.4 in)	15
GLQ	145 (d > 0.59 in) 73 (d < 0.59 in)	44 (d < 0.59 in)	15

shear wave transducer			
transducer order code	fluid pressure <sup>1</sup> [psi]		
	metal pipe		plastic pipe
	min.	min. extended	min.
GSG	435	290	15
GSK	435	290	15
GSM	435	290	15
GSP	435	290	15
GSQ	435	290	15

<sup>1</sup> depending on application, typical absolute value for natural gas, nitrogen, compressed air  
d = inner pipe diameter

**Example**

step					
1	pipe wall thickness selected transducer	in	0.56 GLG or GLH	0.34 GLH or GLK	1.5 GS
2	inner pipe diameter max. flow velocity selected transducer	in ft/s	22.9 49 GLG	3.8 98 GLK	5.6 98 GSK
3	min. fluid pressure selected transducer	psi	290 GLG	218 GLK	580 GSK

**Step 4**

for the characters 4 to 11 of the transducer order code (ambient temperature, explosion protection, connection system, extension cable) see page 12

**Step 5**

for the technical data of the selected transducer see page 13 et seqq.

### Transducer order code

1, 2	3	4	5, 6	7, 8	9 to 11	no. of character	description	
transducer	transducer frequency	-	ambient temperature	explosion protection	connection system	-	extension cable	
GL							set of ultrasonic flow transducers for gas measurement, Lamb wave	
GS							set of ultrasonic flow transducers for gas measurement, shear wave	
	F						0.15 MHz (Lamb wave only)	
	G						0.2 MHz	
	H						0.3 MHz (Lamb wave only)	
	K						0.5 MHz	
	M						1 MHz	
	P						2 MHz	
	Q						4 MHz	
			N				normal temperature range	
			E				extended temperature range (FSM, FSP, FSQ)	
				F2			FM Class I Div. 2	
					NL		with Lemo connector	
						XXX	cable length in m, for max. length of extension cable see page 21	
example								
GL	K	-	N	F2	NL	-	010	Lamb wave transducer 0.5 MHz, normal temperature range, FM Class I Div. 2, connection system NL with Lemo connector and extension cable 10 m
		-				-		

## Technical data

### Shear wave transducers

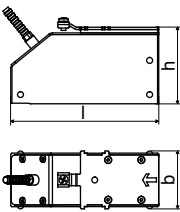
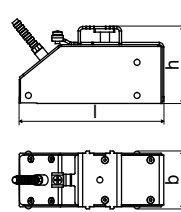
technical type		GDG1N51	GDK1N51
order code		<b>GSG-NF2NL</b>	<b>GSK-NF2NL</b>
transducer frequency	MHz	0.2	0.5
<b>fluid pressure<sup>1</sup></b>			
min. extended	psi	metal pipe: 290	metal pipe: 290
min.	psi	metal pipe: 435 plastic pipe: 15	metal pipe: 435 plastic pipe: 15
<b>inner pipe diameter d<sup>2</sup></b>			
min. extended	in	7.1	2.4
min. recommended	in	8.7	3.1
max. recommended	in	35.4	11.8
max. extended	in	43.3	14.2
<b>pipe wall thickness</b>			
min.	in	0.43	0.2
<b>material</b>			
housing		PEEK with stainless steel cap 304	PEEK with stainless steel cap 304
contact surface		PEEK	PEEK
degree of protection		NEMA 6	NEMA 6
<b>transducer cable</b>			
type		1699	1699
length	ft	16	16
<b>dimensions</b>			
length l	in	5.1	4.98
width b	in	2.01	2.01
height h	in	2.64	2.66
dimensional drawing			
<b>ambient temperature</b>			
min.	°F	-40	-40
max.	°F	+266	+266
temperature compensation		x	x
<b>explosion protection</b>			
F M	order code	GSG-NF2NL	GSK-NF2NL
	<b>explosion protection temperature</b>		
	min.	°F	-40
	max.	°F	+257
	marking		NI/Cl. I,II,III/Div. 2 / GP A,B,C,D,E,F,G/ Temp. Codes dwg 3860
type of protection		non incendive	

<sup>1</sup> depending on application, typical absolute value for natural gas, nitrogen, compressed air

<sup>2</sup> shear wave transducer:

typical values for natural gas, nitrogen, oxygen, pipe diameters for other fluids on request

inner pipe diameter max. recommended/max. extended: in reflect arrangement and for a flow velocity of 49 ft/s

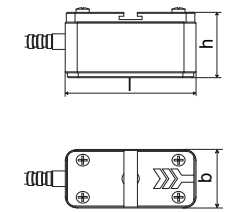
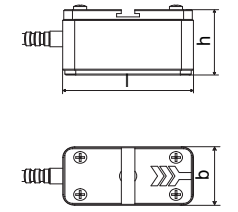
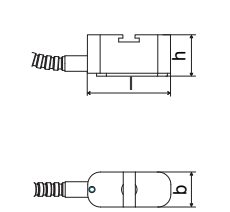
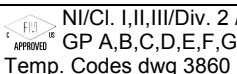
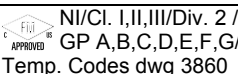
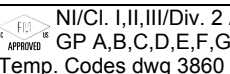
technical type		GDM1N51	GDP1N51	GDQ1N51
order code		<b>GSM-NF2NL</b>	<b>GSP-NF2NL</b>	<b>FSQ-NF2NL</b>
transducer frequency	MHz	1	2	4
<b>fluid pressure<sup>1</sup></b>				
min. extended	psi	metal pipe: 290	metal pipe: 290	metal pipe: 290
min.	psi	metal pipe: 435 plastic pipe: 15	metal pipe: 435 plastic pipe: 15	metal pipe: 435 plastic pipe: 15
<b>inner pipe diameter d<sup>2</sup></b>				
min. extended	in	1.2	0.59	0.24
min. recommended	in	1.6	0.79	0.39
max. recommended	in	3.1	1.6	0.79
max. extended	in	4.7	2.4	1.2
<b>pipe wall thickness</b>				
min.	in	0.1	0.06	0.04
<b>material</b>				
housing		stainless steel 304	stainless steel 304	stainless steel 304
contact surface		PEEK	PEEK	PEEK
degree of protection		NEMA 6	NEMA 6	NEMA 6
<b>transducer cable</b>				
type		1699	1699	1699
length	ft	13	13	9
<b>dimensions</b>				
length l	in	2.36	2.36	1.67
width b	in	1.18	1.18	0.71
height h	in	1.32	1.32	0.85
dimensional drawing				
<b>ambient temperature</b>				
min.	°F	-40	-40	-40
max.	°F	+266	+266	+266
temperature compensation		x	x	x
<b>explosion protection</b>				
order code		GSM-NF2NL	GSP-NF2NL	FSQ-NF2NL
<b>explosion protection temperature</b>				
min.	°F	-40	-40	-40
max.	°F	+257	+257	+257
marking				
type of protection		non incandive	non incandive	non incandive
remark				on request





<sup>1</sup> depending on application, typical absolute value for natural gas, nitrogen, compressed air

<sup>2</sup> shear wave transducer:

typical values for natural gas, nitrogen, oxygen, pipe diameters for other fluids on request

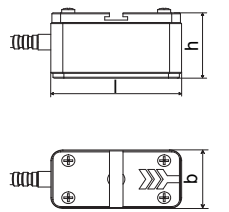
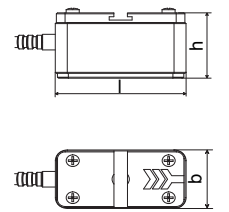
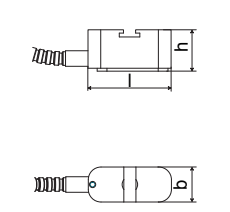
inner pipe diameter max. recommended/max. extended: in reflect arrangement and for a flow velocity of 49 ft/s

**Shear wave transducers (extended temperature range)**

technical type		GDM1E51	GDP1E51	GDQ1E51
order code		<b>GSM-EF2NL</b>	<b>GSP-EF2NL</b>	<b>FSQ-EF2NL</b>
transducer frequency	MHz	1	2	4
<b>fluid pressure<sup>1</sup></b>				
min. extended	psi	metal pipe: 290	metal pipe: 290	metal pipe: 290
min.	psi	metal pipe: 435 plastic pipe: 15	metal pipe: 435 plastic pipe: 15	metal pipe: 435 plastic pipe: 15
<b>inner pipe diameter d<sup>2</sup></b>				
min. extended	in	1.2	0.59	0.28
min. recommended	in	1.6	0.79	0.39
max. recommended	in	5.9	2	0.87
max. extended	in	7.1	2.4	1.2
<b>pipe wall thickness</b>				
min.	in	0.08	0.04	0.02
<b>material</b>				
housing		stainless steel 304	stainless steel 304	stainless steel 304
contact surface		Sintimid	Sintimid	Sintimid
degree of protection		NEMA 4	NEMA 4	NEMA 4
<b>transducer cable</b>				
type		1699	1699	1699
length	ft	13	13	9
<b>dimensions</b>				
length l	in	2.36	2.36	1.67
width b	in	1.18	1.18	0.71
height h	in	1.32	1.32	0.85
dimensional drawing				
<b>ambient temperature</b>				
min.	°F	-22	-22	-22
max.	°F	+392	+392	+392
temperature compensation		x	x	x
<b>explosion protection</b>				
	order code	GSM-EF2NL	GSP-EF2NL	FSQ-EF2NL
	<b>explosion protection temperature</b>			
	min.	°F -40	°F -40	°F -40
	max.	°F +374	°F +374	°F +374
F M	marking	 NI/Cl. I,II,III/Div. 2 / GP A,B,C,D,E,F,G/ Temp. Codes dwg 3860	 NI/Cl. I,II,III/Div. 2 / GP A,B,C,D,E,F,G/ Temp. Codes dwg 3860	 NI/Cl. I,II,III/Div. 2 / GP A,B,C,D,E,F,G/ Temp. Codes dwg 3860
	type of protection	non incensive	non incensive	non incensive
remark				on request





<sup>1</sup> depending on application, typical absolute value for natural gas, nitrogen, compressed air

<sup>2</sup> shear wave transducer:

typical values for natural gas, nitrogen, oxygen, pipe diameters for other fluids on request

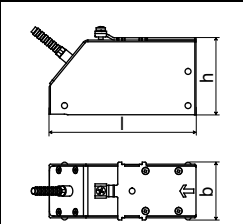
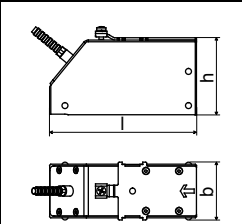
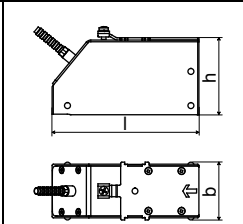
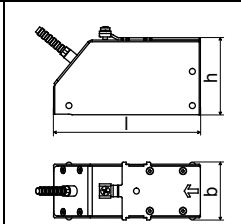
inner pipe diameter max. recommended/max. extended: in reflect arrangement and for a flow velocity of 49 ft/s

**Lamb wave transducers**

technical type		GRF1N51	GRG1N51	GRH1N51	GRK1N51
order code		<b>GLF-NF2NL</b>	<b>GLG-NF2NL</b>	<b>GLH-NF2NL</b>	<b>GLK-NF2NL</b>
transducer frequency	MHz	0.15	0.2	0.3	0.5
<b>fluid pressure<sup>1</sup></b>					
min. extended	psi	metal pipe: 145	metal pipe: 145	metal pipe: 145	metal pipe: 145 (d > 4.7 in) 44 (d < 4.7 in)
min.	psi	metal pipe: 218 plastic pipe: 15	metal pipe: 218 plastic pipe: 15	metal pipe: 218 plastic pipe: 15	metal pipe: 218 (d > 4.7 in) 145 (d < 4.7 in) plastic pipe: 15
<b>inner pipe diameter d<sup>2</sup></b>					
min. extended	in	8.7	7.1	4.3	2.4
min. recommended	in	10.6	8.7	5.5	3.1
max. recommended	in	47.2	35.4	23.6	11.8
max. extended	in	63	55.1	39.4	14.2
<b>pipe wall thickness</b>					
min.	in	0.59	0.43	0.31	0.2
max.	in	1.3	0.94	0.63	0.39
max. extended	in	1.4	-	-	-
<b>material</b>					
housing		PPSU with stainless steel cap 304	PPSU with stainless steel cap 304	PPSU with stainless steel cap 304	PPSU with stainless steel cap 304
contact surface		PPSU	PPSU	PPSU	PPSU
degree of protection		NEMA 4	NEMA 6	NEMA 6	NEMA 6
<b>transducer cable</b>					
type		1699	1699	1699	1699
length	ft	16	16	16	16
<b>dimensions</b>					
length l	in	5.06	5.06	5.06	5.06
width b	in	2.01	2.01	2.01	2.01
height h	in	2.66	2.66	2.66	2.66
dimensional drawing					
<b>ambient temperature</b>					
min.	°F	-40	-40	-40	-40
max.	°F	+338	+338	+338	+338
temperature compensation		x	x	x	x
<b>explosion protection</b>					
order code		GLF-NF2NL	GLG-NF2NL	GLH-NF2NL	GLK-NF2NL
<b>explosion protection temperature</b>					
min.	°F	-40	-40	-40	-40
max.	°F	+329	+329	+329	+329
FM	marking	 NI/Cl. I,II,III/Div. 2 / GP A,B,C,D,E,F,G/Temp. Codes dwg 3860	 NI/Cl. I,II,III/Div. 2 / GP A,B,C,D,E,F,G/Temp. Codes dwg 3860	 NI/Cl. I,II,III/Div. 2 / GP A,B,C,D,E,F,G/Temp. Codes dwg 3860	 NI/Cl. I,II,III/Div. 2 / GP A,B,C,D,E,F,G/Temp. Codes dwg 3860
	type of protection	non incandive	non incandive	non incandive	non incandive

<sup>1</sup> depending on application, typical absolute value for natural gas, nitrogen, compressed air



<sup>2</sup> Lamb wave transducer:

typical values for natural gas, nitrogen, oxygen, pipe diameters for other fluids on request

inner pipe diameter max. recommended: in reflect arrangement (diagonal arrangement) and for a flow velocity of 49 ft/s (98 ft/s)

inner pipe diameter max. extended: in reflect arrangement (diagonal arrangement) and for a flow velocity of 39 ft/s (82 ft/s)

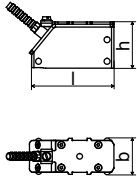
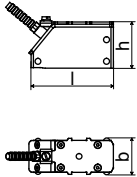
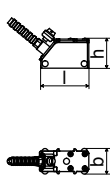

technical type		GRM1N51	GRP1N51	GRQ1N51
order code		<b>GLM-NF2NL</b>	<b>GLP-NF2NL</b>	<b>GLQ-NF2NL</b>
transducer frequency	MHz	1	2	4
<b>fluid pressure<sup>1</sup></b>				
min. extended	psi	metal pipe: 44 (d < 2.4 in)	metal pipe: 44 (d < 1.4 in)	metal pipe: 44 (d < 0.59 in)
min.	psi	metal pipe: 145 (d > 2.4 in) 73 (d < 2.4 in) plastic pipe: 15	metal pipe: 145 (d > 1.4 in) 73 (d < 1.4 in) plastic pipe: 15	metal pipe: 145 (d > 0.59 in) 73 (d < 0.59 in) plastic pipe: 15
<b>inner pipe diameter d<sup>2</sup></b>				
min. extended	in	1.2	0.59	0.28
min. recommended	in	1.6	0.79	0.39
max. recommended	in	5.9	2	0.87
max. extended	in	7.1	2.4	1.2
<b>pipe wall thickness</b>				
min.	in	0.08	0.04	0.02
max.	in	0.2	0.12	0.04
max. extended	in	-	-	-
<b>material</b>				
housing		PPSU with stainless steel cap 304	PPSU with stainless steel cap 304	PPSU with stainless steel cap 304
contact surface		PPSU	PPSU	PPSU
degree of protection		NEMA 4	NEMA 4	NEMA 4
<b>transducer cable</b>				
type		1699	1699	1699
length	ft	13	13	9
<b>dimensions</b>				
length l	in	2.91	2.91	1.65
width b	in	1.26	1.26	0.87
height h	in	1.59	1.59	1
dimensional drawing				
<b>ambient temperature</b>				
min.	°F	-40	-40	-40
max.	°F	+338	+338	+338
temperature compensation		x	x	x
F M	order code	GLM-NF2NL	GLP-NF2NL	GLQ-NF2NL
	<b>explosion protection temperature</b>			
	min.	°F	-67	-67
	max.	°F	+329	+329
	marking		 NI/Cl. I,II,III/Div. 2 / GP A,B,C,D,E,F,G/ Temp. Codes dwg 3860	 NI/Cl. I,II,III/Div. 2 / GP A,B,C,D,E,F,G/ Temp. Codes dwg 3860
type of protection		non incandive	non incandive	non incandive
remark				on request

<sup>2</sup> Lamb wave transducer:

typical values for natural gas, nitrogen, oxygen, pipe diameters for other fluids on request

inner pipe diameter max. recommended: in reflect arrangement (diagonal arrangement) and for a flow velocity of 49 ft/s (98 ft/s)

inner pipe diameter max. extended: in reflect arrangement (diagonal arrangement) and for a flow velocity of 39 ft/s (82 ft/s)

### Transducer mounting fixture

#### Order code

1, 2	3	4	5	6	7 to 9	no. of character		
transducer mounting fixture	transducer	-	measurement arrangement	size	-	fixation	outer pipe diameter	description
VP								portable Variofix
	A							all transducers
			D					reflect arrangement or diagonal arrangement/direct mode
			R					reflect arrangement
				M				medium
						C		chains
						G		tension belts
						N		without fixation
							055	0.39 to 21.7 in
example								
VP	A	-	D	M	-	C	055	portable Variofix and chains
		-			-			

#### portable Variofix VP and chains (optional)

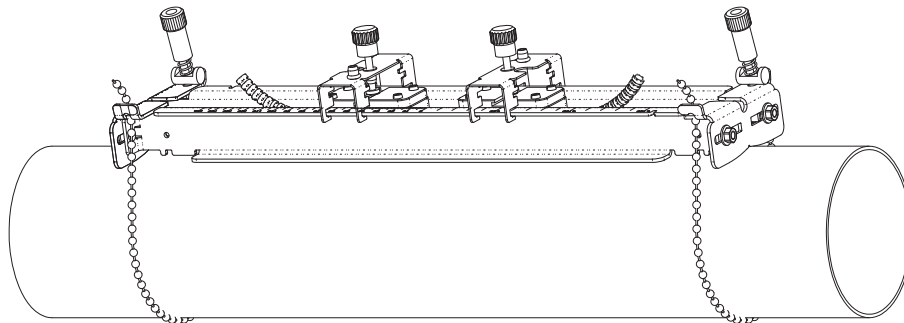

material: stainless steel 304, 301, 303  
 dimensions: 16.3 x 3.7 x 2.99 in  
 chain length: 6 ft

#### portable Variofix VP and tension belts

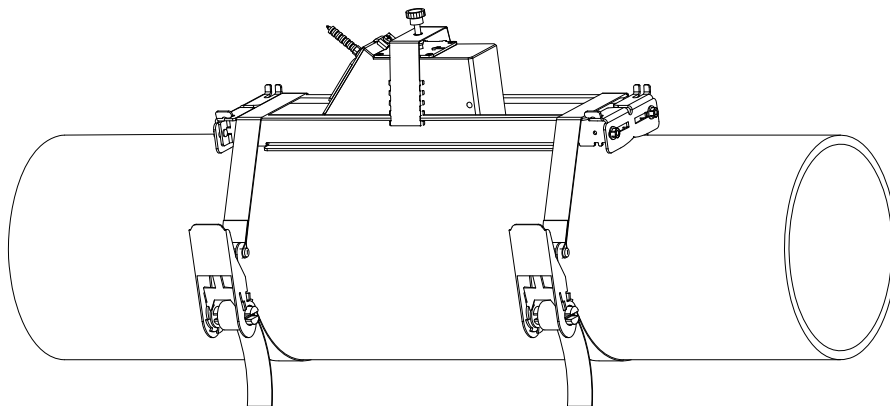

## Coupling materials for transducers

normal temperature range (4th character of transducer order code = N)		extended temperature range (4th character of transducer order code = E)	
< 212 °F	< 338 °F	< 302 °F	< 392 °F
coupling compound type N	coupling compound type E	coupling compound type E	coupling compound type E or H

### Technical data

type	ambient temperature °F	material
coupling compound type N	-22 to +266	mineral grease paste
coupling compound type E	-22 to +392	silicone paste
coupling compound type H	-22 to +482	fluoropolymer paste

### Damping mats (optional)

Damping mats will be used for the gas measurement to reduce acoustic noise influences on the measurement.

Transducer damping mats will be installed below the transducers.

Pipe damping mats will be installed at reflection points, e.g. flange, weld.

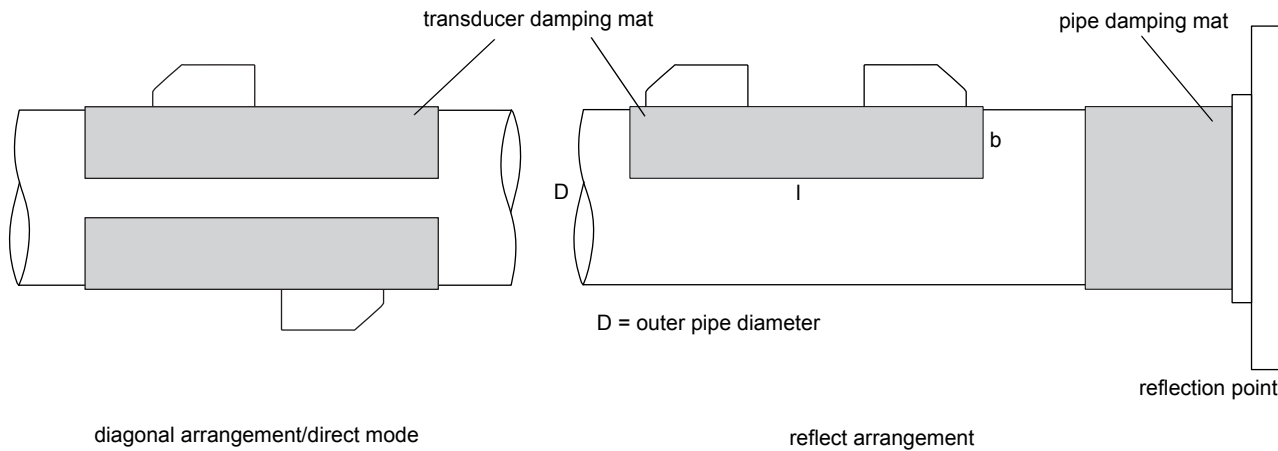

### Selection of damping mats

type	description	outer pipe diameter in	dimensions l x b x h in	transducer frequency								technical type	ambient temperature °F	remark
				F	G	H	K	M	P	Q				
<b>transducer damping mat</b>														
D	for temporary installation (multiple use), fixed with coupling compound	< 3.1	17.72 x 4.53 x 0.02	-	-	-	-	x	x	x	x	D20S3	-13 to +140	
		≥ 3.1	35.43 x 9.06 x 0.02	-	-	-	x	x	-	-	D20S2			
			35.43 x 9.06 x 0.05	x	x	x	-	-	-	-	D50S2			
<b>pipe damping mat</b>														
A	for temporary installation (multiple use), fixed with coupling compound	< 11.8	11.81 x 4.53 x 0.02	x	x	x	x	x	x	x	x	A20S4	-13 to +140	for quantity see table below
B	self-adhesive	≥ 11.8	l x 3.94 x 0.04	x	x	x	x	x	x	-	B35R2	-31 to +122	l - see table below	

### Quantity for pipe damping mat - type A

(depending on the outer pipe diameter)

outer pipe diameter D in	transducer frequency	
	F, G, H	K, M, P, Q
3.9	12	6
7.9	24	12
11.8	32	16

### Length of pipe damping mat - type B

(length l depending on transducer frequency and outer pipe diameter)

outer pipe diameter D in	transducer frequency	
	F, G, H ft	K, M, P ft
11.8	39	19
19.7	104	52
39.4	413	206

## Connection systems

### connection system NL

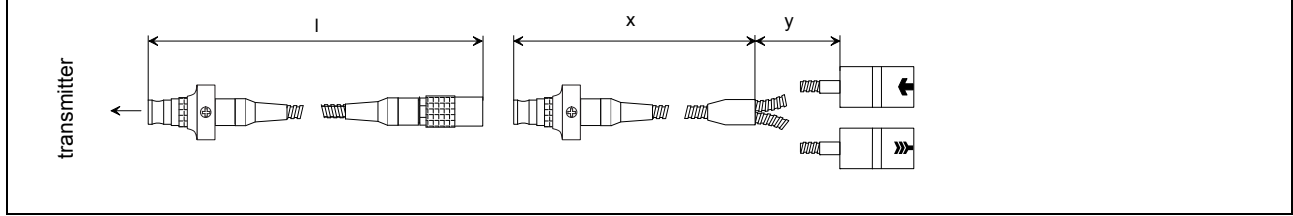

transducer frequency (3d character of transducer order code)		F, G, H, K			M, P			Q			S		
<b>N</b>		<b>x</b>	<b>y</b>	<b>l</b>	<b>x</b>	<b>y</b>	<b>l</b>	<b>x</b>	<b>y</b>	<b>l</b>	<b>x</b>	<b>y</b>	<b>l</b>
<b>L</b>	cable length ft	6	9	≤ 32	6	6	≤ 32	6	3	≤ 32	3	3	≤ 32

x, y = transducer cable length

l = max. length of extension cable

## Transducer cable

### Technical data

		transducer cable	extension cable
type		1699	1750
standard length	ft	see table above	16 32
max. length	ft	-	32
ambient temperature	°F	-67 to +392	< 144
<b>cable jacket</b>			
material		PTFE	PE
outer diameter	in	0.11	0.24
thickness	in	0.01	0.02
color		brown	black
shield		x	x
<b>sheath</b>			
material		stainless steel 304	stainless steel 304
outer diameter	in	0.31	0.35

## Clamp-on temperature probe (optional)

### Technical data

technical type		<b>PT13N</b>	<b>PT13F</b>
design			short response time
type		Pt1000	Pt1000
connection		4-wire	4-wire
measuring range	°F	-40 to +392	-58 to +482
accuracy T		$\pm(0.27 \text{ }^\circ\text{F} + 2 \cdot 10^{-3} \cdot ( T \text{ [}^\circ\text{F]}  - 32 \text{ }^\circ\text{F}))$ class A	$\pm(0.27 \text{ }^\circ\text{F} + 2 \cdot 10^{-3} \cdot ( T \text{ [}^\circ\text{F]}  - 32 \text{ }^\circ\text{F}))$ class A
accuracy $\Delta T$ (2x Pt matched according to EN 1434-1)		$\leq 0.03 \text{ }^\circ\text{F}$ (at 50 °F)	$\leq 0.1 \text{ K}$ (3 K < $\Delta T$ < 6 K), more corresponding to EN 1434-1
response time	s		8
housing		360 brass alloy	PEEK, stainless steel 304, copper
degree of protection			NEMA 4
weight	lb	0.437	0.7
fixation		clamp-on	clamp-on
<b>accessories</b>			
thermal conductivity paste 392 °F		-	x
thermal conductivity foil 482 °F		x	x
plastic protection plate, insulation foam		-	x
<b>dimensions</b>			
length l	in	0.59	0.55
width b	in	0.49	1.18
height h	in	0.79	1.06

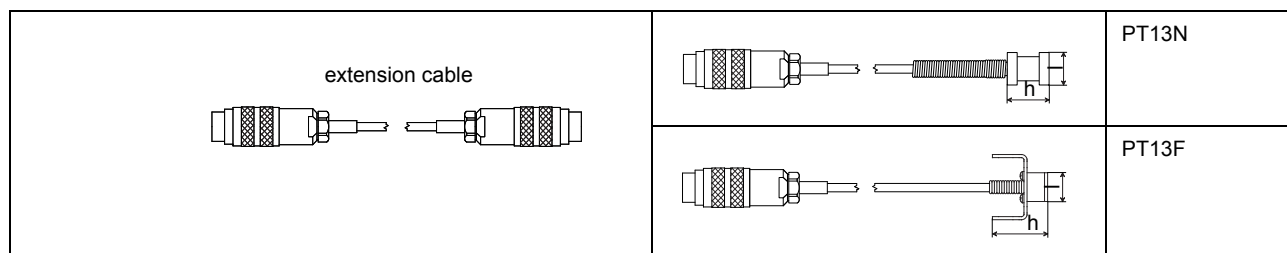

### Connector

pin	cable of temperature probe PT13F	cable of temperature probe PT13N	extension cable
1	white/blue	white	white
2	red/blue	red	black
3, 4, 5	not connected		
6	red	red	green
7	white	white	red
8	not connected		

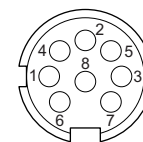

### Cable

		cable of temperature probe		extension cable
temperature probe		PT13F	PT13N	
type		4 x 0.25 mm <sup>2</sup> black	4 x 24 AWG	4 x 18 AWG
standard length	ft	9	20	-
max. length	ft	-	-	328
cable jacket		PTFE	PTFE	LS PVC

### Wall thickness measurement (optional)

The pipe wall thickness is an important pipe parameter which has to be determined exactly for a good measurement. However, the pipe wall thickness often is unknown.

The wall thickness probe can be connected to the transmitter instead of the flow transducers and the wall thickness measurement mode is activated automatically.

Acoustic coupling compound is applied to the wall thickness probe which then is placed firmly on the pipe. The wall thickness is displayed and can be stored directly in the transmitter.

### Technical data

technical type		DWR1NZ7
measuring range <sup>1</sup>	in	0.04 to 9.8
resolution	in	0.0004
accuracy		1 % ± 0.004 in
fluid temperature	°F	-4 to +392, short-time peak max. 932
explosion protection		-
<b>cable</b>		
type		2616
length	ft	4

<sup>1</sup> The measuring range depends on the attenuation of the ultrasonic signal in the pipe. For strongly attenuating plastics (e.g. PFA, PTFE, PP) the measuring range is smaller.

### Cable

type		2616
ambient temperature	°F	<392
<b>cable jacket</b>		
material		FEP
outer diameter	in	0.2
color		black
shield		x

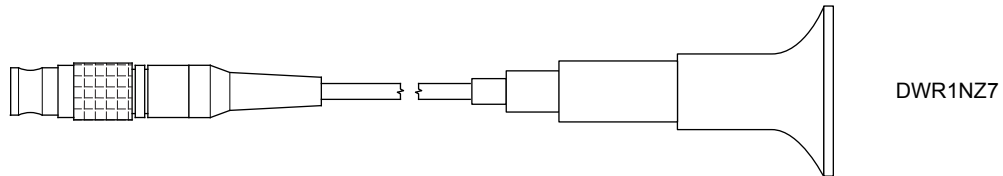



FLEXIM AMERICAS Corporation  
Edgewood, NY 11717  
USA  
Tel.: (631) 492-2300  
Fax: (631) 492-2117

internet: [www.flexim.com](http://www.flexim.com)  
e-mail: [usinfo@flexim.com](mailto:usinfo@flexim.com)  
1-888-852-7473

Subject to change without notification. Errors excepted.  
FLUXUS® is a registered trademark of FLEXIM GmbH.