

### Portable ultrasonic flow measurement of liquids in hazardous areas

Portable instrument for non-invasive, quick ultrasonic flow measurement with clamp-on technology for all types of piping

#### Features

- Precise bi-directional and highly dynamic flow measurement with the non-invasive clamp-on technology
- High precision at fast and slow flow rates, high temperature and zero point stability
- Portable, easy-to-use flow transmitter with 2 flow channels, multiple inputs, an integrated data logger with a serial interface
- Extremely resistant carbon fiber housing
- Covered by FM Class I Div. 2 certification
- Compact and very lightweight, allowing the measuring system to be easily carried as personal luggage, e.g. for offshore visits
- Water tight; resistant against oil, many liquids and dirt
- Li-Ion battery provides up to 25 hours of measurement operation
- Automatic loading of calibration data and transducer detection for a fast and easy set-up (less than 5 min), providing precise and long-term stable results
- User-friendly design
- Transducers available for a wide range of inner pipe diameters and fluid temperatures (-170...+600 °C)
- Rugged transducers (FM Class I Div. 2, resistant to rough environments and humidity)
- Robust, water-tight (IP67) transport case with comprehensive accessories
- HybridTrek automatically switches between transit time and NoiseTrek mode of measurement when high particulate flows are encountered
- QuickFix for fast mounting of the flow transmitter in difficult conditions
- Measurement is unaffected by fluid density, viscosity and solid content (max. 10 % of volume)

#### Applications

Designed for the following industries:

- Upstream (on- and offshore)
- Midstream and downstream (pipelines and refineries)
- Chemical industry
- Energy sector (e.g. HVAC, geothermal, power plants)



FLUXUS F608 supported by handle



Measurement with transducers mounted with the portable Variofix VP



Measurement with the flow transmitter fixed to the pipe with the QuickFix pipe mounting fixture

## Table of contents

<b>Function</b> .....	3
Measurement principle .....	3
Calculation of volumetric flow rate .....	3
Number of sound paths .....	4
Typical measurement setup .....	4
<b>Flow transmitter</b> .....	5
Technical data .....	5
Dimensions .....	6
Standard scope of supply .....	7
Adapters (optional) .....	7
<b>Transducers</b> .....	8
Transducer selection .....	8
Transducer order code .....	9
Technical data .....	10
<b>Transducer mounting fixture</b> .....	13
<b>Coupling materials for transducers</b> .....	15
<b>Connection systems</b> .....	16
Transducer cable .....	16
<b>Clamp-on temperature probe (optional)</b> .....	17
<b>Wall thickness measurement (optional)</b> .....	19

## Function

### Measurement principle

#### Transit time difference principle

In order to measure the flow of a fluid in a pipe, ultrasonic signals are used, employing the transit time difference principle. Ultrasonic signals are emitted by a transducer installed on the pipe and received by a second transducer. These signals are emitted alternately in the flow direction and against it.

As the fluid in which the signals propagate is flowing, the transit time of the ultrasonic signals in the flow direction is shorter than against the flow direction.

The transit time difference,  $\Delta t$ , is measured and allows the flowmeter to determine the average flow velocity along the propagation path of the ultrasonic signals. A flow profile correction is then performed in order to obtain the area averaged flow velocity, which is proportional to the volumetric flow rate.

Two integrated microprocessors control the entire measuring process. This allows the flowmeter to remove disturbance signals, and to check each received ultrasonic wave for its validity which reduces noise.

#### HybridTrek

If the gaseous or solid content in the fluid increases occasionally during measurement, a measurement with the transit time difference principle is no longer possible. NoiseTrek mode will then be selected by the flowmeter. This measurement method allows the flowmeter to achieve a stable measurement even with high gaseous or solid content.

The transmitter can switch automatically between transit time and NoiseTrek mode without any changes to the measurement setup.

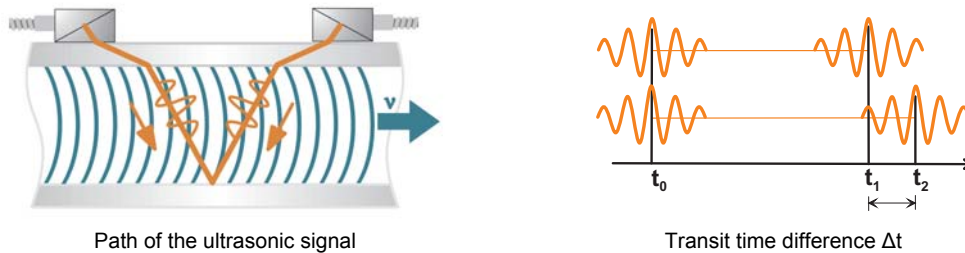

### Calculation of volumetric flow rate

$$\dot{V} = k_{Re} \cdot A \cdot k_a \cdot \Delta t / (2 \cdot t_{fl})$$

where

- $\dot{V}$  - volumetric flow rate
- $k_{Re}$  - fluid mechanics calibration factor
- $A$  - cross-sectional pipe area
- $k_a$  - acoustical calibration factor
- $\Delta t$  - transit time difference
- $t_{fl}$  - transit time in the fluid

### Number of sound paths

The number of sound paths is the number of transits of the ultrasonic signal through the fluid in the pipe. Depending on the number of sound paths, the following methods of installation exist:

- reflection arrangement**  
 The number of sound paths is even. Both of the transducers are mounted on the same side of the pipe. Correct positioning of the transducers is easier.
- diagonal arrangement**  
 The number of sound paths is odd. Both of the transducers are mounted on opposite sides of the pipe. In the case of a high signal attenuation by the fluid, pipe and coatings, diagonal arrangement with 1 sound path will be used.

The preferred method of installation depends on the application. While increasing the number of sound paths increases the accuracy of the measurement, signal attenuation increases as well. The optimum number of sound paths for the parameters of the application will be determined automatically by the transmitter.

As the transducers can be mounted with the transducer mounting fixture in reflection arrangement or diagonal arrangement, the number of sound paths can be adjusted optimally for the application.

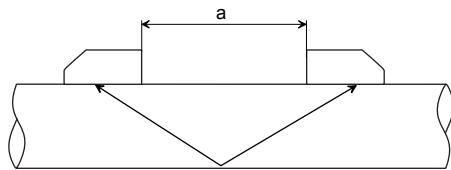

Reflection arrangement, number of sound paths: 2

a - transducer distance

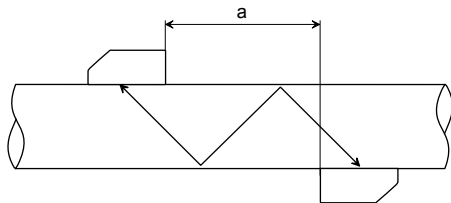

Diagonal arrangement, number of sound paths: 3

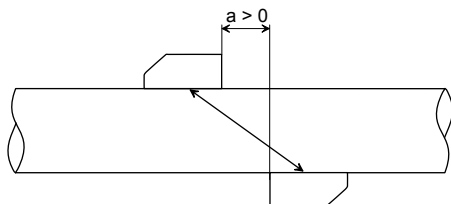

Diagonal arrangement, number of sound paths: 1

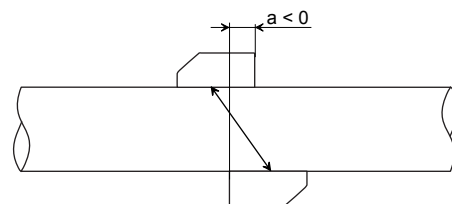

Diagonal arrangement, number of sound paths: 1, negative transducer distance

### Typical measurement setup

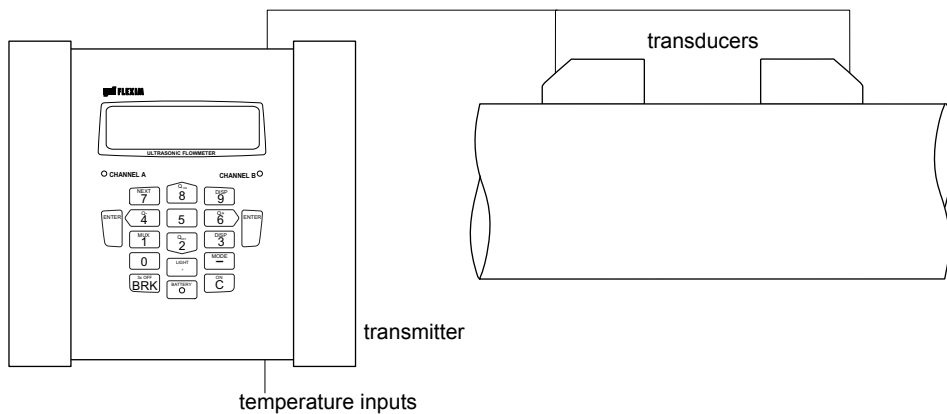

Example of a reflection arrangement

## Flow transmitter

### Technical data

<b>FLUXUS</b>	<b>F608**-F2</b>
design	portable, FM class I Div. 2
	
<b>measurement</b>	
measurement principle	transit time difference correlation principle, automatic NoiseTrek selection for measurements with high gaseous or solid content
flow velocity	0.01...25 m/s
repeatability	0.15 % of reading ±0.01 m/s
fluid	all acoustically conductive liquids with < 10 % gaseous or solid content in volume (transit time difference principle)
temperature compensation	corresponding to the recommendations in ANSI/ASME MFC-5.1-2011
<b>accuracy<sup>1</sup></b>	
with standard calibration	±1.6 % of reading ±0.01 m/s
with advanced calibration (optional)	±1.2 % of reading ±0.01 m/s
with field calibration <sup>2</sup>	±0.5 % of reading ±0.01 m/s
<b>flow transmitter</b>	
power supply	100...230 V/50...60 Hz (power supply unit, outside of explosive atmosphere) 10.5...15 V DC (socket at transmitter, with power adapter (optional)) integrated battery
integrated battery - operating time	Li-Ion, 7.2 V/6.2 Ah > 14 h (without inputs and backlight) > 25 h (1 measuring channel, ambient temperature > 10 °C, without inputs and backlight)
power consumption	< 6 W (with inputs and backlight)
number of flow measuring channels	2
damping	0...100 s, adjustable
measuring cycle (1 channel)	100...1000 Hz
response time	1 s (1 channel), option: 70 ms
housing material	PA, TPS, PC, Polyester, stainless steel
degree of protection according to IEC/EN 60529	IP65
dimensions	see dimensional drawing
weight	2.2 kg
fixation	QuickFix pipe mounting fixture
ambient temperature	-10 ... +60 °C
display	2 x 16 characters, dot matrix, backlight
menu language	English, German, French, Dutch, Spanish
<b>explosion protection</b>	
<b>F M</b> marking	NI/CI. I /Div. 2/ GP. A,B,C,D / T5 Ta = 60 °C

<sup>1</sup> for transit time difference principle, reference conditions and v > 0.15 m/s

<sup>2</sup> reference uncertainty < 0.2 %

<b>FLUXUS</b>	<b>F608**-F2</b>
<b>measuring functions</b>	
physical quantities	volumetric flow rate, mass flow rate, flow velocity, heat flow (if temperature inputs are installed)
totalizer	volume, mass, optional: heat quantity
calculation functions	average, difference, sum
diagnostic functions	sound speed, signal amplitude, SNR, SCNR, standard deviation of amplitudes and transit times
<b>communication interfaces</b>	
diagnostic interfaces	- RS232 - USB (with adapter)
<b>serial data kit</b>	
software	- FluxDiagReader: download of measured values and parameters, graphical presentation - FluxDiag (optional): download of measurement data, graphical presentation, report generation - FluxSubstanceLoader: upload of fluid data sets
cable	RS232
adapter	RS232 - USB
<b>data logger</b>	
loggable values	all physical quantities, totaled values and diagnostic values
capacity	> 100 000 measured values
<b>transport case</b>	
dimensions	500 x 400 x 190 mm
<b>inputs</b>	
	The inputs are galvanically isolated from the transmitter.
number	max. 4
accessories	input adapter (if number of inputs > 2)
<b>temperature input</b>	
type	Pt100/Pt1000
connection	4-wire
range	-150...+560 °C
resolution	0.01 K
accuracy	±0.01 % of reading ±0.03 K

## Dimensions

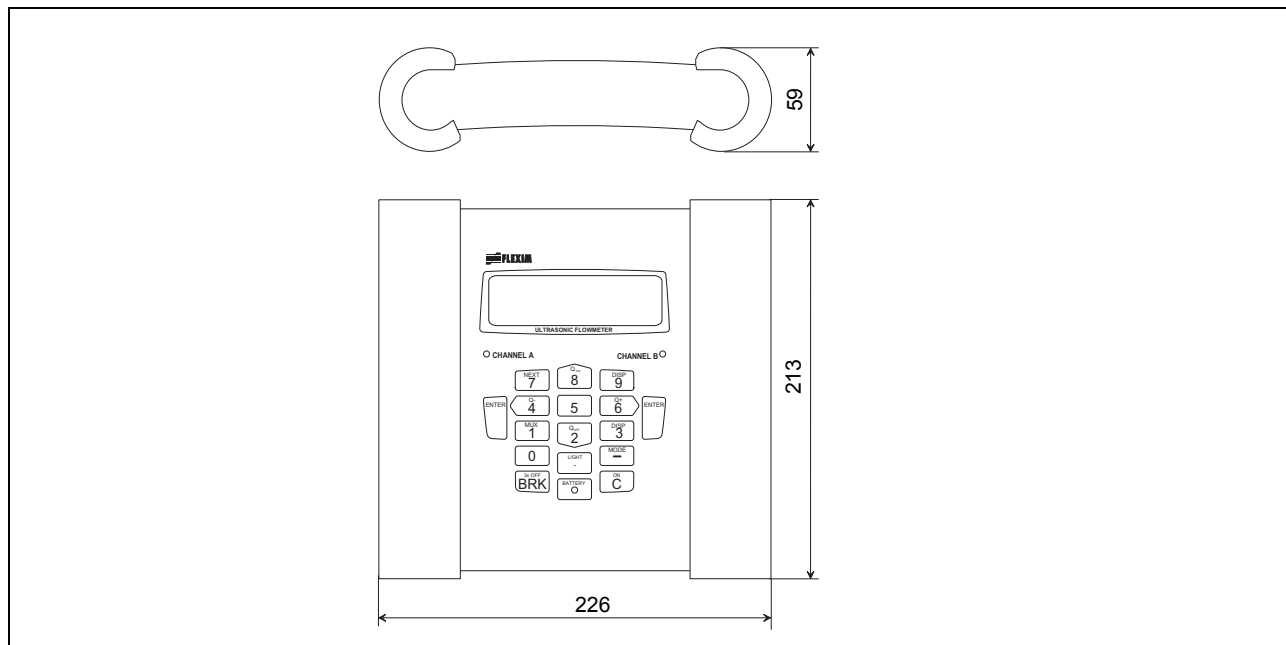

in mm

### Standard scope of supply

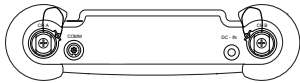
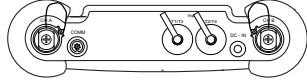
	F608 Standard	F608 Energy
application	flow measurement of liquids	
	2 independent measuring channels	
		temperature-compensated calculation of mass flow rate
		integrated heat flow computer for monitoring of energy flows
		simultaneous monitoring of flow and energy flow
<b>inputs</b>		
temperature input	-	2
<b>accessories</b>		
transport case	x	x
power supply unit, mains cable	x	x
battery	x	x
QuickFix pipe mounting fixture for transmitter	x	x
serial data kit	x	x
measuring tape	x	x
user manual, safety instructions, Quick start guide	x	x
connector board at the upper side of the transmitter		

### Adapters (optional)

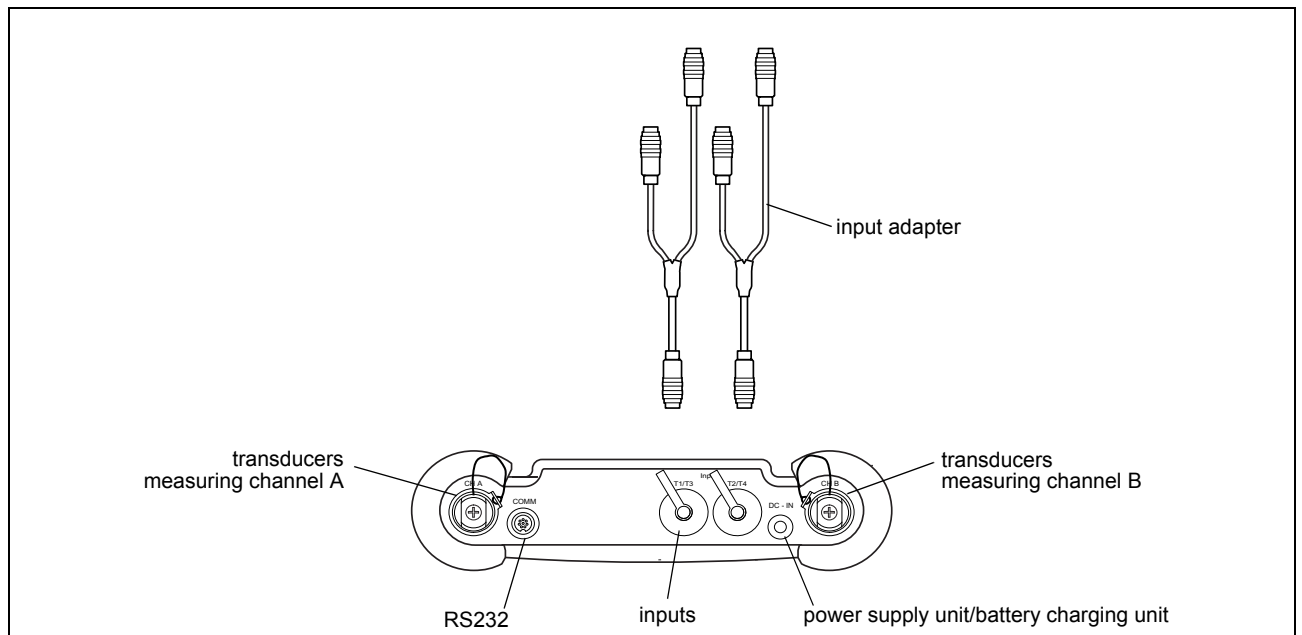

# Transducers

## Transducer selection

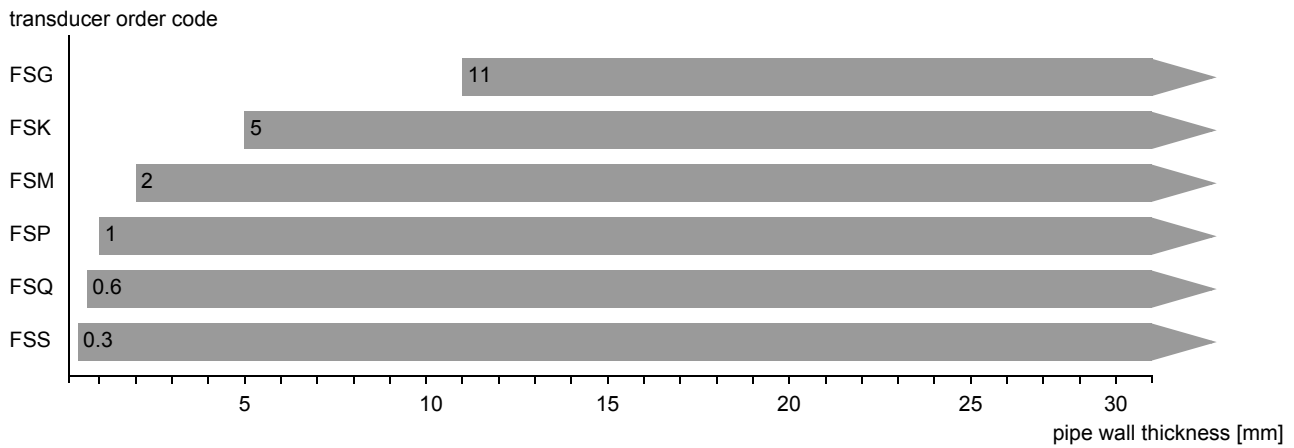
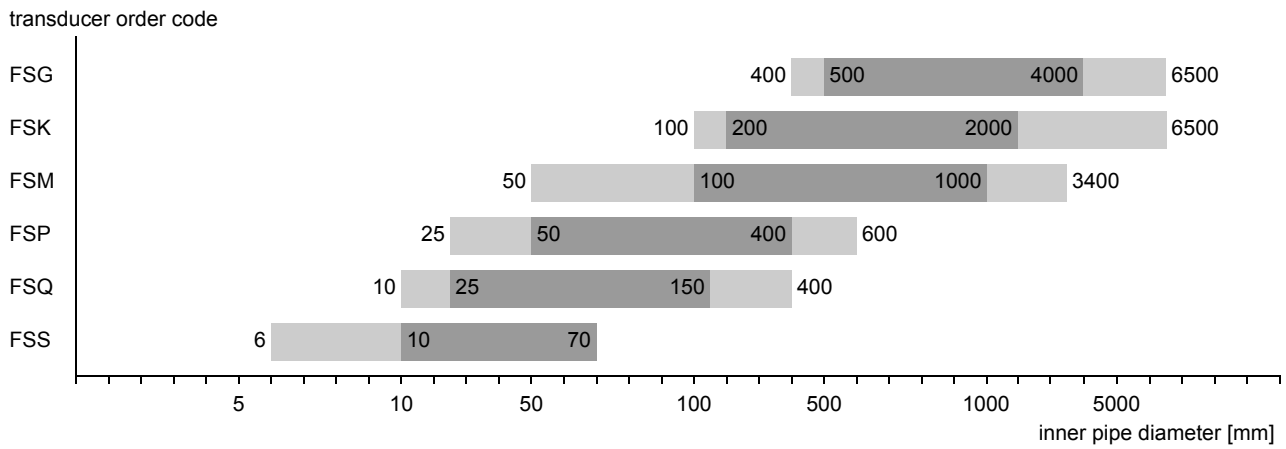

recommended
  possible









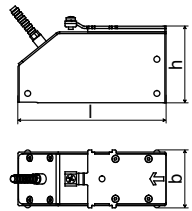
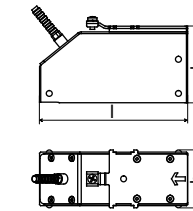
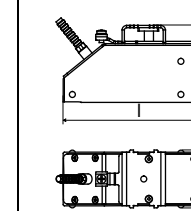
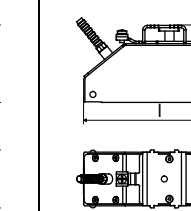

**Transducer order code**

1, 2	3	4	5, 6	7, 8	9...11	12, 13	no. of character			
transducer	transducer frequency	-	ambient temperature	explosion protection	connection system	-	extension cable	/	option	description
FS										set of ultrasonic flow transducers for liquids measurement, shear wave
	G									0.2 MHz
	K									0.5 MHz
	M									1 MHz
	P									2 MHz
	Q									4 MHz
	S									8 MHz
			N							normal temperature range
			E							extended temperature range (FSM, FSP, FSQ)
				F2						FM Class I Div. 2
					NL					with Lemo connector
						XXX				cable length in m, for max. length of extension cable see page 16
								LC		long transducer cable
example										
FS	M	-	N	F2	NL	-	010			shear wave transducer 1 MHz, normal temperature range, FM Class I Div. 2, connection system NL with Lemo connector and extension cable 10 m
		-				-		/		



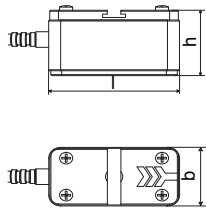
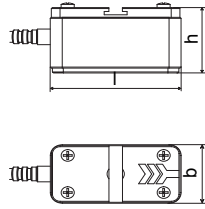
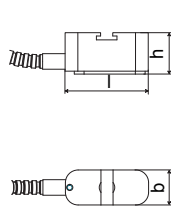
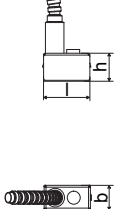

## Technical data

### Shear wave transducers

technical type		CDG1N51	CLG1N51	CDK1N51	CLK1N51	
order code		<b>FSG-NF2NL</b>	<b>FSG-NF2NL/LC</b>	<b>FSK-NF2NL</b>	<b>FSK-NF2NL/LC</b>	
transducer frequency	MHz	0.2	0.2	0.5	0.5	
<b>inner pipe diameter d</b>						
min. extended	mm	400	400	100	100	
min. recommended	mm	500	500	200	200	
max. recommended	mm	4000	4000	2000	2000	
max. extended	mm	6500	6500	6500	6500	
<b>pipe wall thickness</b>						
min.	mm	11	11	5	5	
<b>material</b>						
housing		PEEK with stainless steel cap 304 (1.4301)	PEEK with stainless steel cap 304 (1.4301)	PEEK with stainless steel cap 304 (1.4301)	PEEK with stainless steel cap 304 (1.4301)	
contact surface		PEEK	PEEK	PEEK	PEEK	
degree of protection according to IEC/EN 60529		IP67	IP67	IP67	IP67	
<b>transducer cable</b>						
type		1699	1699	1699	1699	
length	m	5	9	5	9	
<b>dimensions</b>						
length l	mm	129.5	129.5	126.5	126.5	
width b	mm	51	51	51	51	
height h	mm	67	67	67.5	67.5	
dimensional drawing						
<b>ambient temperature</b>						
min.	°C	-40	-40	-40	-40	
max.	°C	+130	+130	+130	+130	
temperature compensation		x	x	x	x	
<b>explosion protection</b>						
<b>F M</b>	<b>explosion protection temperature</b>					
	min.	°C	-40	-40	-40	-40
	max.	°C	+125	+125	+125	+125
	marking		 NI/Cl. I,II,III/Div. 2 / GP A,B,C,D,E,F,G/ Temp. Codes dwg 3860	 NI/Cl. I,II,III/Div. 2 / GP A,B,C,D,E,F,G/ Temp. Codes dwg 3860	 NI/Cl. I,II,III/Div. 2 / GP A,B,C,D,E,F,G/ Temp. Codes dwg 3860	 NI/Cl. I,II,III/Div. 2 / GP A,B,C,D,E,F,G/ Temp. Codes dwg 3860
type of protection		non incandive	non incandive	non incandive	non incandive	
remark		on request	on request			

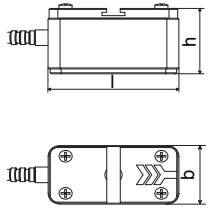
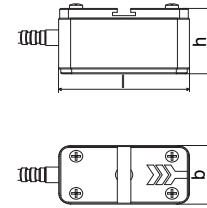
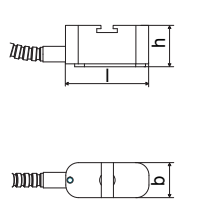
technical type		CDM1N51	CDP1N51	CDQ1N51	CDS1N51
order code		<b>FSM-NF2NL</b>	<b>FSP-NF2NL</b>	<b>FSQ-NF2NL</b>	<b>FSS-NF2NL</b>
transducer frequency	MHz	1	2	4	8
<b>inner pipe diameter d</b>					
min. extended	mm	50	25	10	6
min. recommended	mm	100	50	25	10
max. recommended	mm	2000	200	150	70
max. extended	mm	3400	600	400	70
<b>pipe wall thickness</b>					
min.	mm	2.5	1.5	1	
<b>material</b>					
housing		stainless steel 304 (1.4301)	stainless steel 304 (1.4301)	stainless steel 304 (1.4301)	stainless steel 304 (1.4301)
contact surface		PEEK	PEEK	PEEK	PEI
degree of protection according to IEC/ EN 60529		IP67	IP67	IP67	IP67
<b>transducer cable</b>					
type		1699	1699	1699	1699
length	m	4	4	3	2
<b>dimensions</b>					
length l	mm	60	60	42.5	25
width b	mm	30	30	18	13
height h	mm	33.5	33.5	21.5	17
dimensional drawing					
<b>ambient temperature</b>					
min.	°C	-40	-40	-40	-30
max.	°C	+130	+130	+130	+130
temperature compensation		x	x	x	-
<b>explosion protection</b>					
<b>explosion protection temperature</b>					
F M	min.	°C	-40	-40	-40
	max.	°C	+125	+125	+125
	marking		 NI/Cl. I,II,III/Div. 2 / GP A,B,C,D,E,F,G/ Temp. Codes dwg 3860	 NI/Cl. I,II,III/Div. 2 / GP A,B,C,D,E,F,G/ Temp. Codes dwg 3860	 NI/Cl. I,II,III/Div. 2 / GP A,B,C,D,E,F,G/ Temp. Codes dwg 3860
type of protection		non incensive	non incensive	non incensive	non incensive

**Shear wave transducers (extended temperature range)**

technical type		CDM1E51	CDP1E51	CDQ1E51
order code		<b>FSM-EF2NL</b>	<b>FSP-EF2NL</b>	<b>FSQ-EF2NL</b>
transducer frequency	MHz	1	2	4
<b>inner pipe diameter d</b>				
min. extended	mm	50	25	10
min. recommended	mm	100	50	25
max. recommended	mm	1000	400	150
max. extended	mm	3400	600	400
<b>pipe wall thickness</b>				
min.	mm	2	1	0.6
<b>material</b>				
housing		stainless steel 304 (1.4301)	stainless steel 304 (1.4301)	stainless steel 304 (1.4301)
contact surface		Sintimid	Sintimid	Sintimid
degree of protection according to IEC/EN 60529		IP65	IP65	IP65
<b>transducer cable</b>				
type		1699	1699	1699
length	m	4	4	3
<b>dimensions</b>				
length l	mm	60	60	42.5
width b	mm	30	30	18
height h	mm	33.5	33.5	21.5
dimensional drawing				
<b>ambient temperature</b>				
min.	°C	-30	-30	-30
max.	°C	+200	+200	+200
temperature compensation		x	x	x
<b>explosion protection</b>				
<b>explosion protection temperature</b>				
min.	°C	-40	-40	-40
max.	°C	+190	+190	+190
<b>F M</b>	marking	 NI/Cl. I,II,III/Div. 2 / GP A,B,C,D,E,F,G/ Temp. Codes dwg 3860	 NI/Cl. I,II,III/Div. 2 / GP A,B,C,D,E,F,G/ Temp. Codes dwg 3860	 NI/Cl. I,II,III/Div. 2 / GP A,B,C,D,E,F,G/ Temp. Codes dwg 3860
	type of protection	non incendive	non incendive	non incendive

### Transducer mounting fixture

#### Order code

1, 2	3	4	5	6	7...9	no. of character		
transducer mounting fixture	transducer	-	measurement arrangement	size	-	fixation	outer pipe diameter	description
FS								fastening shoes (transducers with transducer frequency S)
VP								portable Variofix
TB								tension belts
WL								transducer box for WaveInjector
	A							all transducers
	K							transducers with transducer frequency G, K
	M							transducers with transducer frequency M, P
	Q							transducers with transducer frequency Q
	S							transducers with transducer frequency S
		D						reflection arrangement or diagonal arrangement
		R						reflection arrangement
			S					small
			M					medium
					C			chains
					N			without fixation
						010		10...100 mm
						025		10...250 mm
						055		10...550 mm
						150		50...1500 mm
						210		50...2100 mm
example								
VP	A	-	D	M	-	C	055	portable Variofix and chains
		-			-			

#### fastening shoes FS and chains

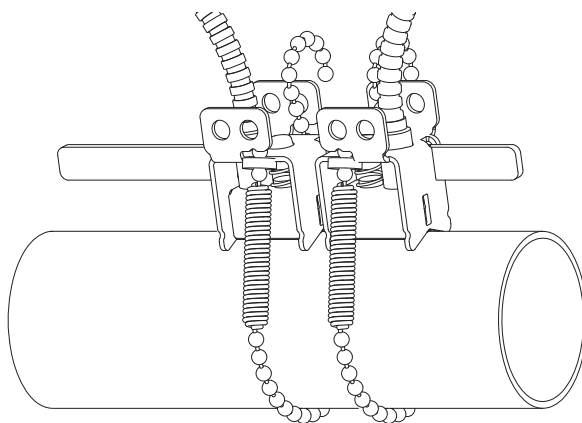

transducer frequency: S

material: stainless steel 304 (1.4301), 301 (1.4310), 303 (1.4305)

dimensions: 210 x 32 x 44 mm

chain length: 0.5 m

outer pipe diameter: max. 150 mm

**portable Variofix VP and chains**

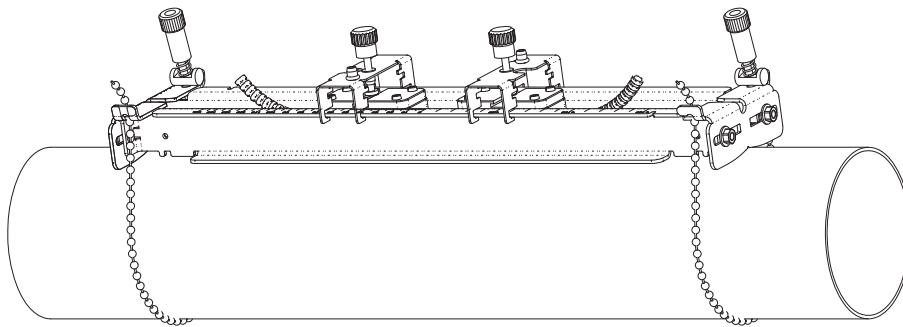

material: stainless steel 304 (1.4301), 301 (1.4310), 303 (1.4305)  
 dimensions: 414 x 94 x 76 mm  
 chain length: 2 m

**tension belts TB**

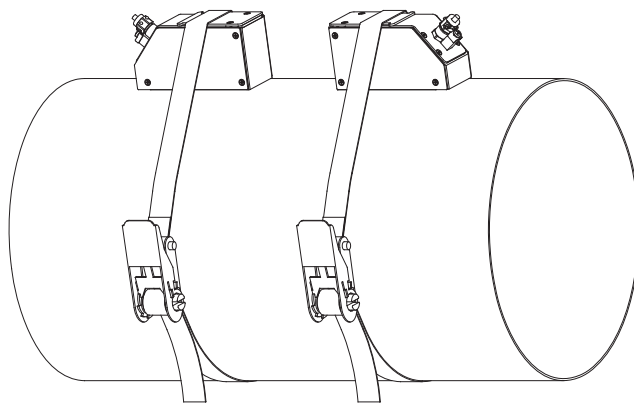

material: steel, powder coated and textile tension belt  
 length: 5/7 m

ambient temperature: max. 60 °C  
 outer pipe diameter: max. 1500/2100 mm

**transducer box WL for WaveInjector**

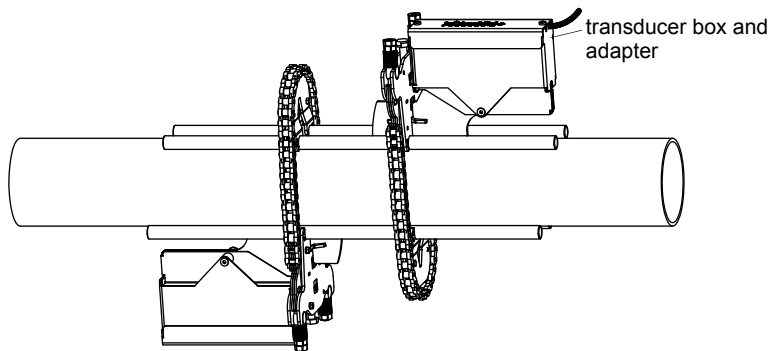

see Technical specification TSWaveInjectorVx-x

## Coupling materials for transducers

normal temperature range (4th character of transducer order code = N)		extended temperature range (4th character of transducer order code = E)		Waveinjector WI-400	
< 100 °C	< 170 °C	< 150 °C	< 200 °C	< 280 °C	280...400 °C
coupling compound type N	coupling compound type E	coupling compound type E	coupling compound type E or H	coupling foil type A and coupling foil type VT	coupling foil type B and coupling foil type VT

### Technical data

type	ambient temperature °C	material
coupling compound type N	-30...+130	mineral grease paste
coupling compound type E	-30...+200	silicone paste
coupling compound type H	-30...+250	fluoropolymer paste
coupling foil type A	max. 280	lead
coupling foil type B	> 280...400	silver
coupling foil type VT	-10...+200	fluoroelastomer

## Connection systems

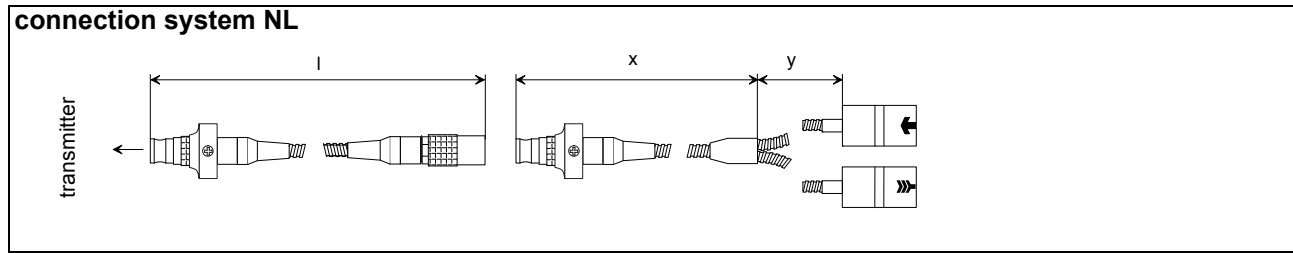

transducer frequency (3d character of transducer order code)		F, G, H, K			M, P			Q			S			
<b>N</b>		<b>x</b>	<b>y</b>	<b>l</b>	<b>x</b>	<b>y</b>	<b>l</b>	<b>x</b>	<b>y</b>	<b>l</b>	<b>x</b>	<b>y</b>	<b>l</b>	
<b>L</b>	cable length	m	2	3	$\leq 10$	2	2	$\leq 10$	2	1	$\leq 10$	1	1	$\leq 10$
	cable length (option LC)	m	2	7	$\leq 10$	7	2	$\leq 10$	8	1	$\leq 10$	-	-	-

x, y - transducer cable length

l - max. length of extension cable

## Transducer cable

### Technical data

		transducer cable	extension cable
type		1699	1750
standard length	m	see table above	5 10
max. length	m	-	10
ambient temperature	°C	-55...+200	< 80
<b>cable jacket</b>			
material		PTFE	PE
outer diameter	mm	2.9	6
thickness	mm	0.3	0.5
colour		brown	black
shield		x	x
<b>sheath</b>			
material		stainless steel 304 (1.4301)	stainless steel 304 (1.4301)
outer diameter	mm	8	9



## Clamp-on temperature probe (optional)

### Technical data

technical type		<b>PT12N</b>	<b>PT12F</b>
design			short response time
type		Pt100	Pt100
connection		4-wire	4-wire
measuring range	°C	-30...+250	-50...+250
accuracy T		$\pm(0.15 \text{ °C} + 2 \cdot 10^{-3} \cdot  T \text{ [°C] })$ class A	$\pm(0.15 \text{ °C} + 2 \cdot 10^{-3} \cdot  T \text{ [°C] })$ class A
accuracy $\Delta T$ (2x Pt matched according to EN 1434-1)		$\leq 0.1 \text{ K}$ ( $3 \text{ K} < \Delta T < 6 \text{ K}$ ), more corresponding to EN 1434-1	$\leq 0.1 \text{ K}$ ( $3 \text{ K} < \Delta T < 6 \text{ K}$ ), more corresponding to EN 1434-1
response time	s	50	8
housing		aluminum	PEEK, stainless steel 304 (1.4301), copper
degree of protection according to IEC/ EN 60529		IP66	IP66
weight (without connector)	kg	0.25	0.32
fixation		clamp-on	clamp-on
<b>accessories</b>			
thermal conductivity paste 200 °C		x	x
thermal conductivity foil 250 °C		x	x
plastic protection plate, insulation foam		-	x
<b>dimensions</b>			
length l	mm	15	14
width b	mm	15	30
height h	mm	20	27

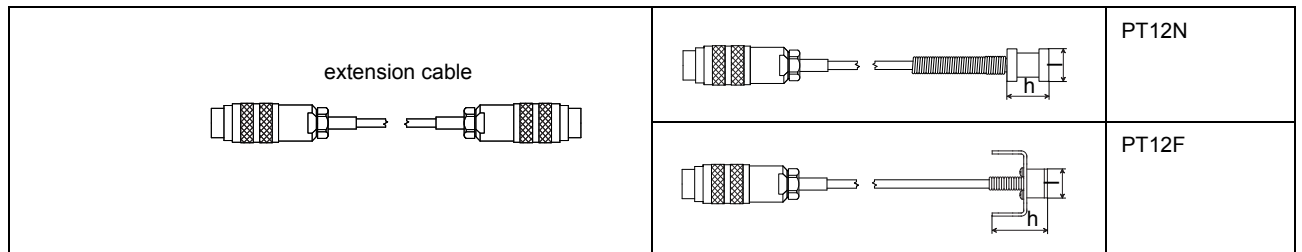

### Connection

#### Temperature probe

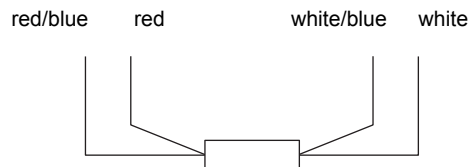

## Connector

pin	cable of temperature probe	extension cable
1	white/blue	blue
2	red/blue	grey
3, 4, 5	not connected	
6	red	red
7	white	white
8	not connected	

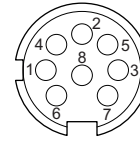

## Cable

		cable of temperature probe	extension cable
type		4 x 0.25 mm <sup>2</sup> black	LIYCY 8 x 0.14 mm <sup>2</sup> grey
standard length	m	3	5/10/25
max. length	m	-	100
cable jacket		PTFE	PVC

### Wall thickness measurement (optional)

The pipe wall thickness is an important pipe parameter which has to be determined exactly for a good measurement. However, the pipe wall thickness often is unknown.

The wall thickness probe can be connected to the transmitter instead of the flow transducers and the wall thickness measurement mode is activated automatically.

Acoustic coupling compound is applied to the wall thickness probe which then is placed firmly on the pipe. The wall thickness is displayed and can be stored directly in the transmitter.

### Technical data

technical type		DWR1NZ7
measuring range <sup>1</sup>	mm	1...250
resolution	mm	0.01
accuracy		1 % ± 0.1 mm
fluid temperature	°C	-20...+200, short-time peak max. 500
explosion protection		-
<b>cable</b>		
type		2616
length	m	1.5

<sup>1</sup> The measuring range depends on the attenuation of the ultrasonic signal in the pipe. For strongly attenuating plastics (e.g. PFA, PTFE, PP) the measuring range is smaller.

### Cable

type		2616
ambient temperature	°C	<200
<b>cable jacket</b>		
material		FEP
outer diameter	mm	5.1
colour		black
shield		x

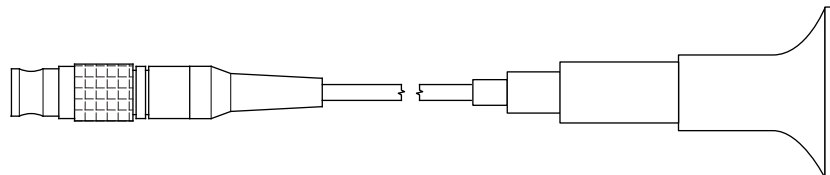

DWR1NZ7



FLEXIM GmbH  
Wolfener Str. 36  
12681 Berlin  
Germany  
Tel.: +49 (30) 93 66 76 60  
Fax: +49 (30) 93 66 76 80

internet: [www.flexim.com](http://www.flexim.com)  
e-mail: [info@flexim.com](mailto:info@flexim.com)

Subject to change without notification. Errors excepted.  
FLUXUS® is a registered trademark of FLEXIM GmbH.

TSFLUXUS\_F608xx-F2V2-1-3EN\_Leu, 2017-05-23